

Note: Drain position central unless dimensioned otherwise

Step Entry

SKU: LQ-RIC-B-RH-ST

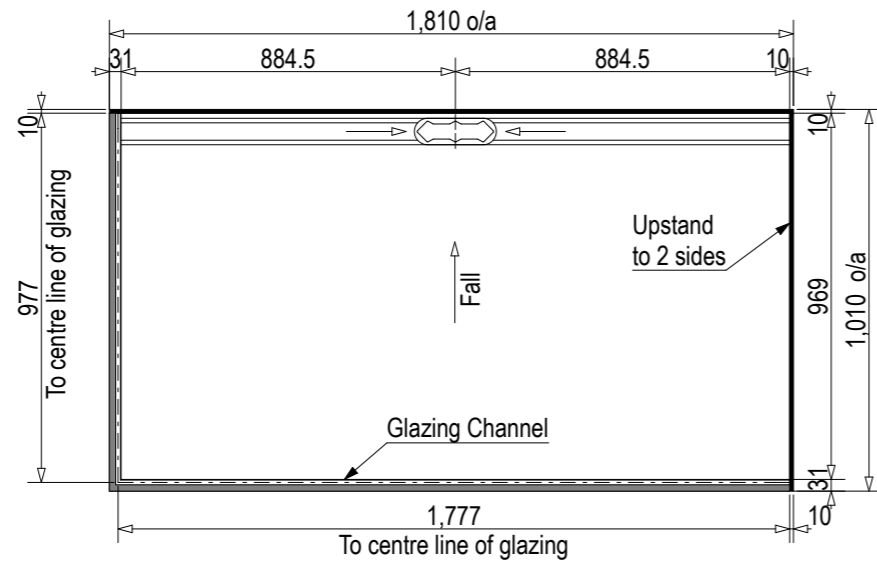

Level Entry

SKU: LQ-RIC-B-RH-LE

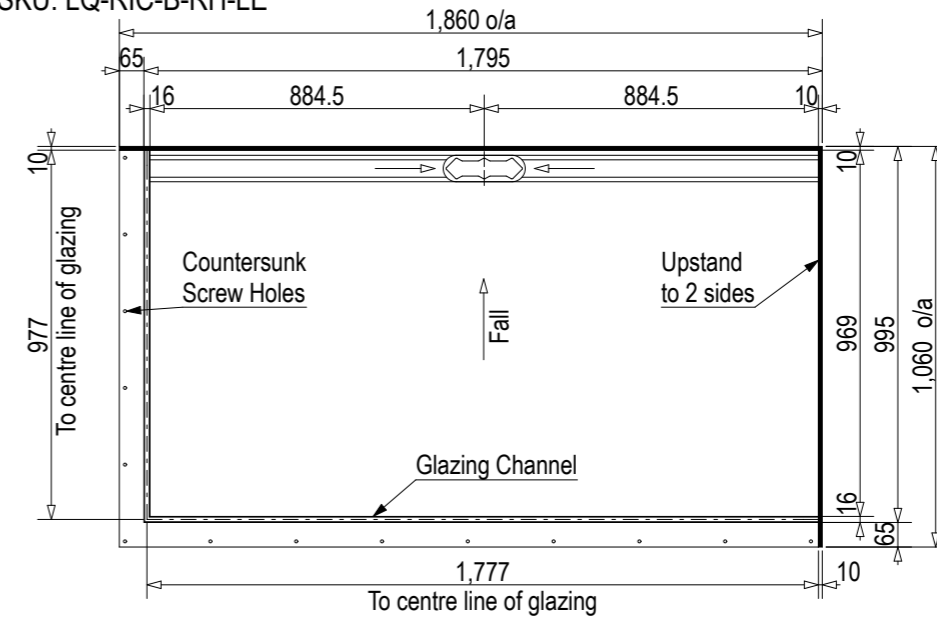

See Waste Channel Recess Specifications for size

Floor Recess 1830x1030x30

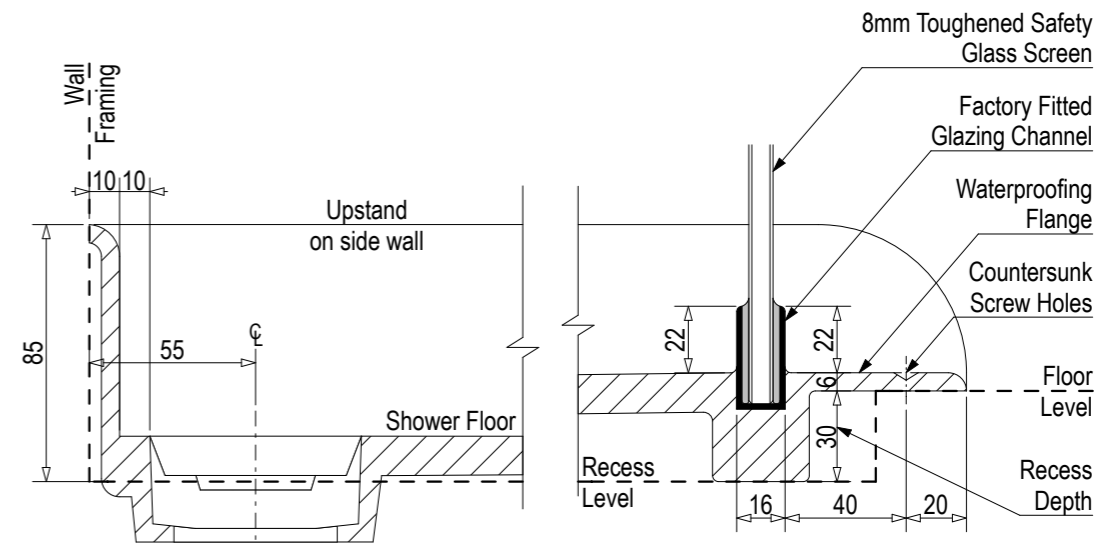
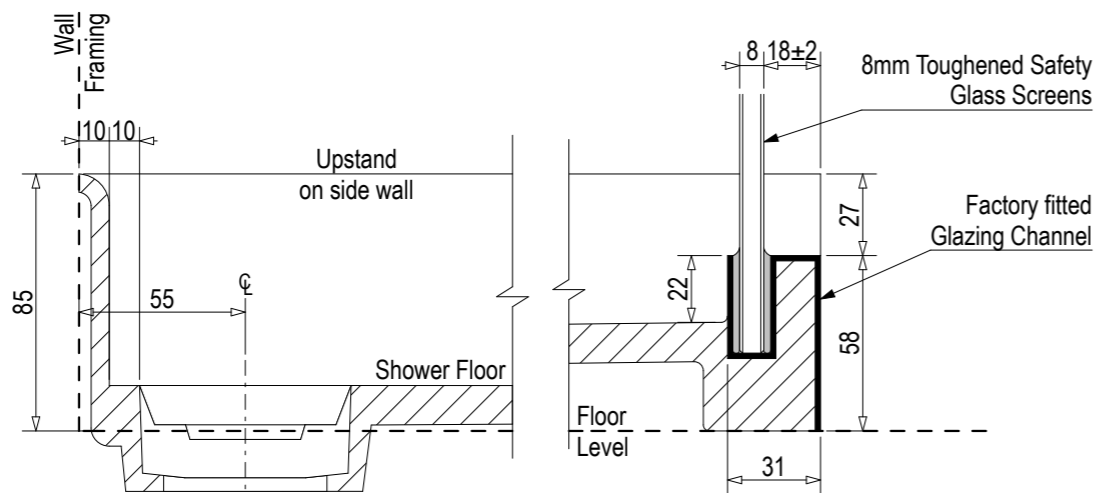
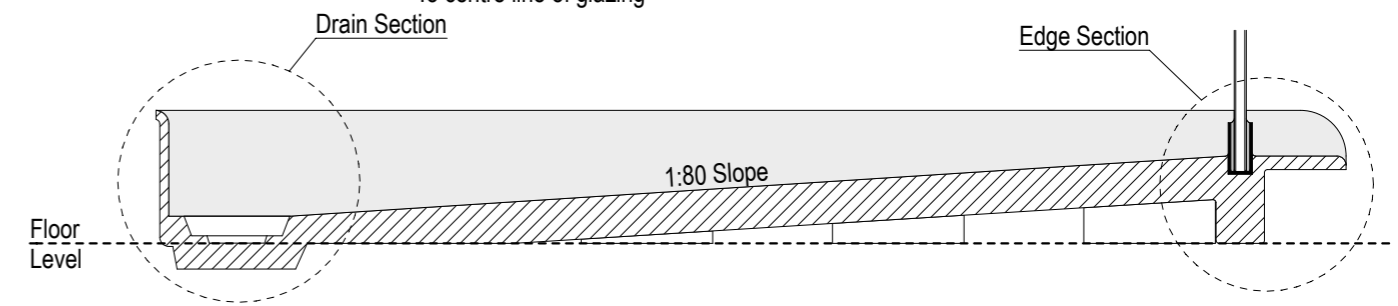
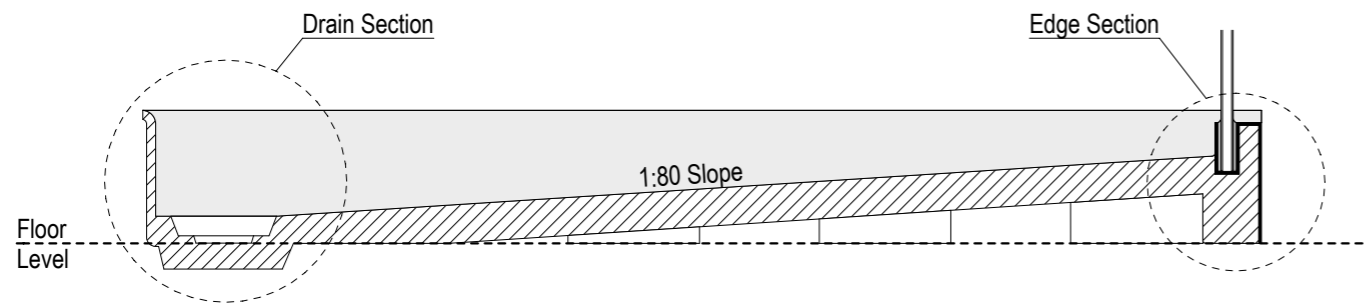
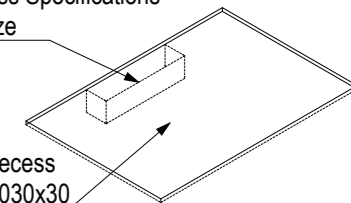

See Waste Channel Recess Specifications for depth information under floor

See Waste Channel Recess Specifications for depth information under floor

Note: Verify exact shower base dimensions on site

Screen Options:

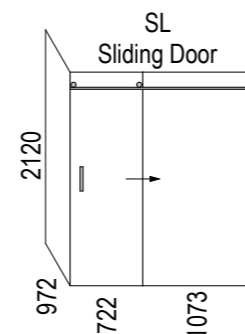
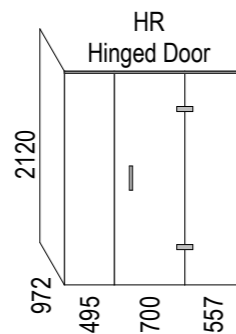

For more product information go to:

www.atlantis.co.nz/shop/linea-quattro/richmond-1800x1000/

For installation instructions go to:

www.atlantis.co.nz/trade/installation/

AQUAPLANE WASTE FITTING

- EasyClean Waste with in-built trap
- 50L/min ultra flow rate
- Removable fin for easy cleaning
- 40/50mm outlet with swivel fitting
- Components bolt together for guaranteed watertightness







