

IMPORTANT INSTALLATION NOTES:



AFTER INSTALLATION, PLEASE CHECK AND TEST:

1. Open the door leaf to its maximum opening angle and release. The door leaf should close fully into the door frame and overcome the latch.
2. Open the door leaf and rest the latch bolt on the striker plate. Release the door leaf. The door closer should have sufficient power to latch the door leaf closed.

Power size	Max. Door width	Max. Door weight	Max. Door opening *	Number of turns
NO.1	750mm	20kg	180°	8CCW
* NO.2	850mm	40kg	180°	0
NO.3	950mm	60kg	180°	7CW

* Factory preset CW :Clockwise CCW:Counterclockwise



WARNING:

1. Mechanical hold open devices must NOT be installed on fire/smoke door.
2. Door closers should NOT be opened beyond the max. opening angle of the fixing type you selected.
3. This door closer contains a powerful spring, which is inserted into the body under pressure. Under no circumstances should any attempt be made to dismantle the door closer.

*Pull Side Regular & Transom Fixing

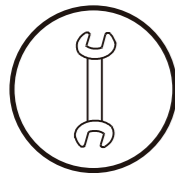

MAINTENANCE:

1. Check the door closer every three months to ensure all fixings are secure and adjust, if necessary, adjust the closing and latching speed, and check door functionally and smooth operation.
2. Apply light oil to arm knuckle joint and door hinges.

Regular Fixing - Pull Side

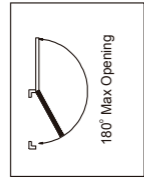
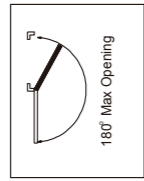
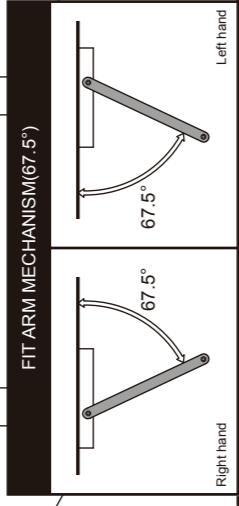
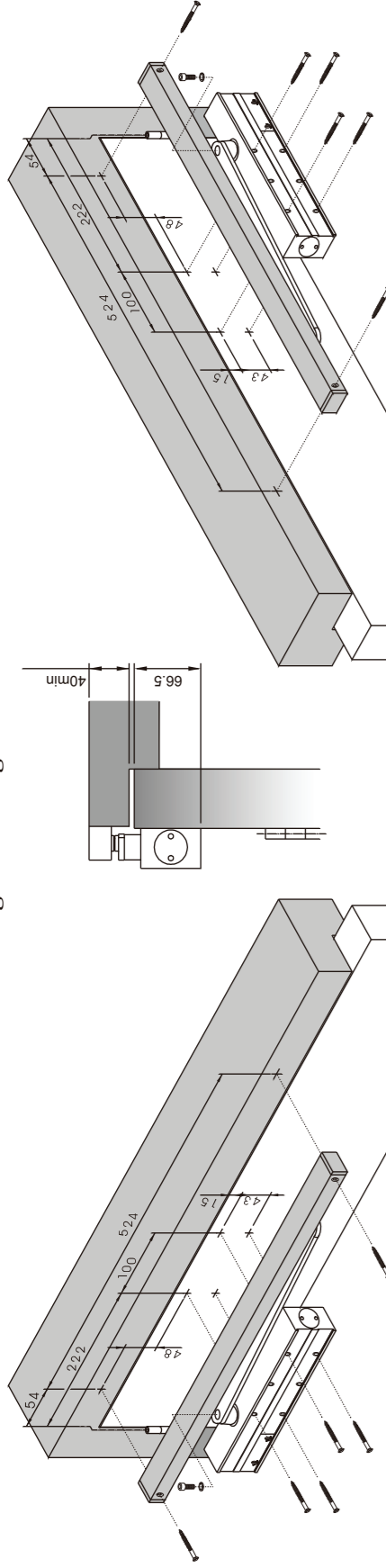

Transom Fixing - Pull Side

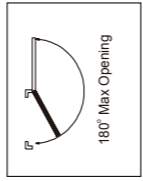
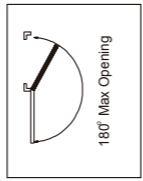
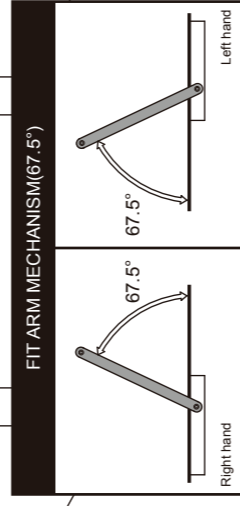
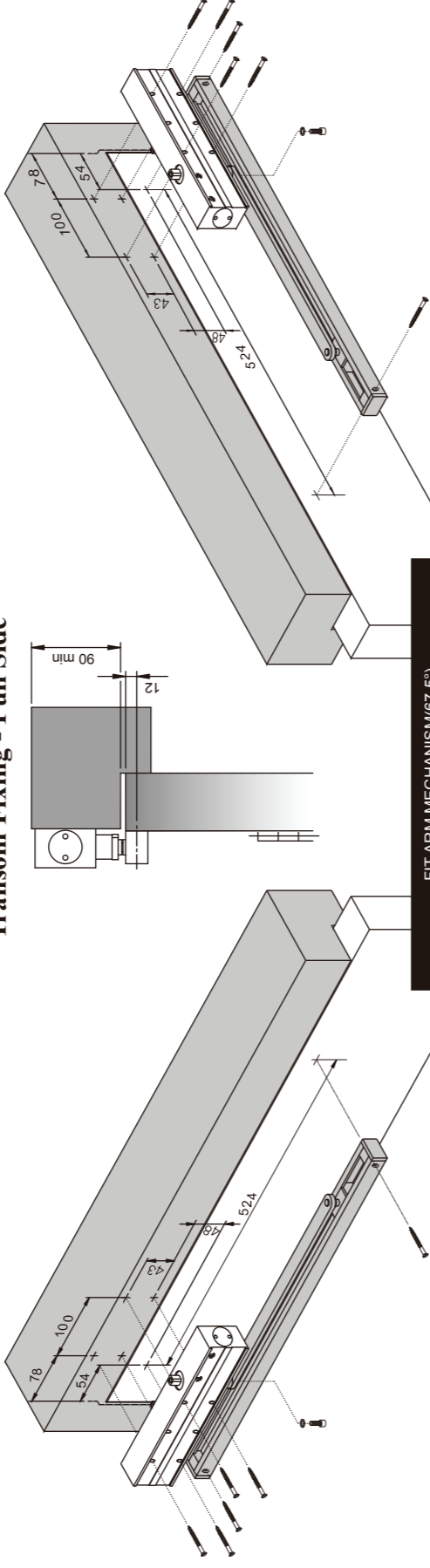

Regular Fixing-Push Side

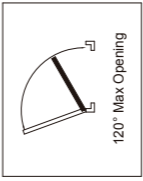
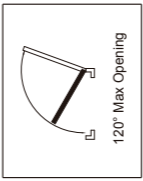
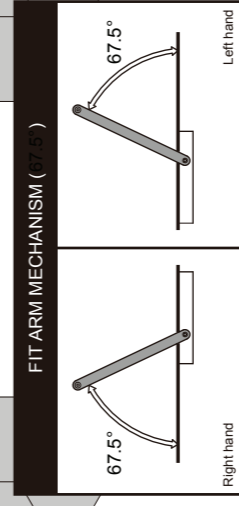
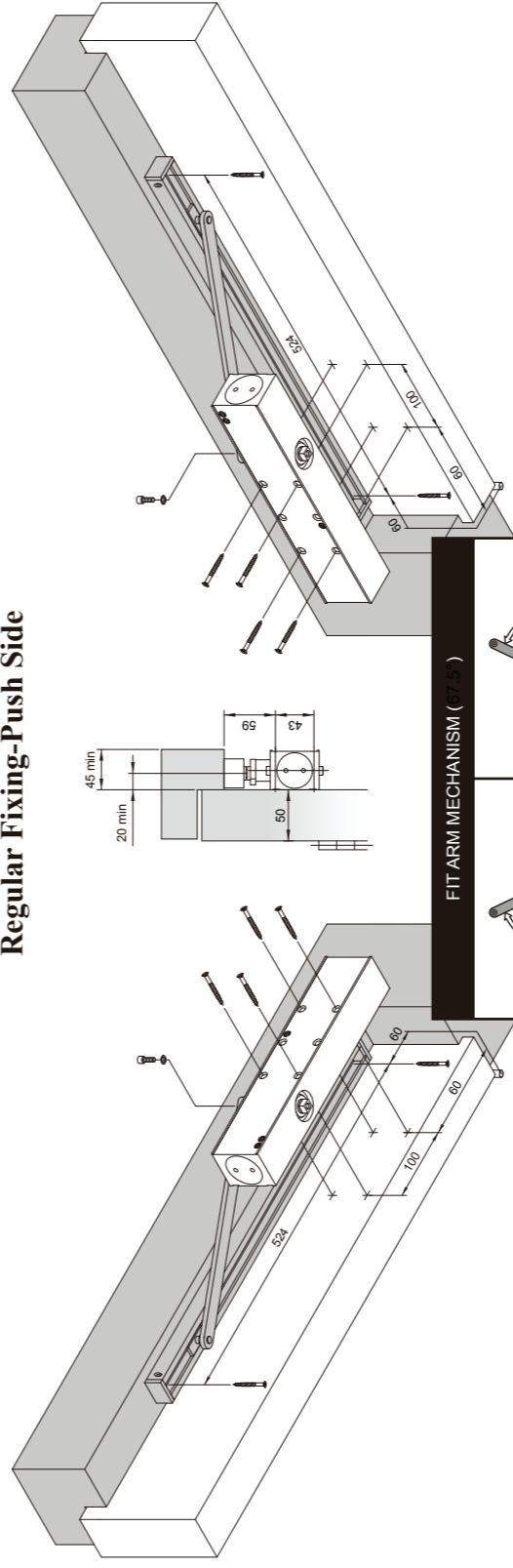

Transom Fixing - Push Side

