

85mm CONCRETE + 220mm PODS

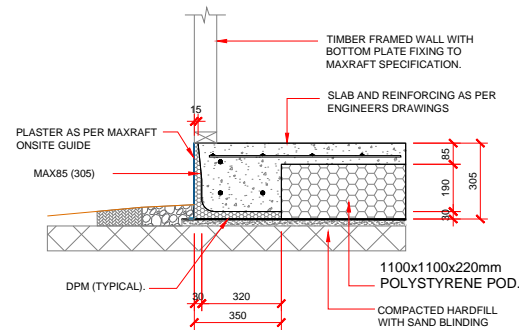

EXTERNAL FOOTING DETAIL
15mm TAPERED - 30mm BOTTOM

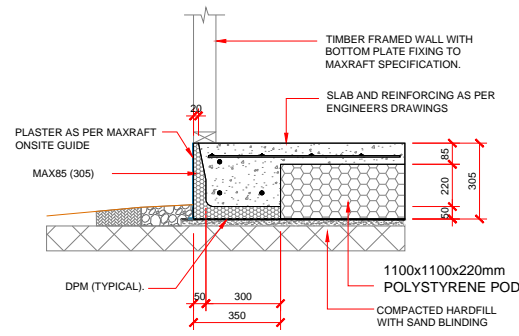

EXTERNAL FOOTING DETAIL
20mm TAPERED - 50mm BOTTOM

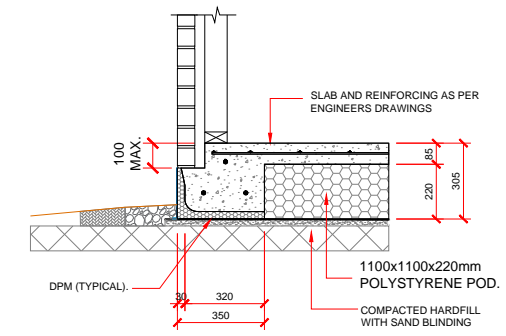

BRICK / STONE VENEER
REBATE DETAIL

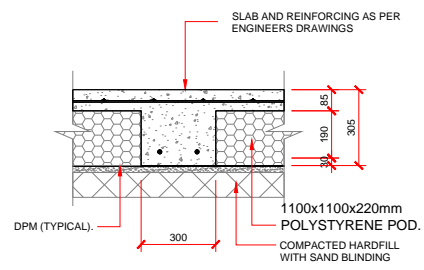

INTERNAL FOOTING DETAIL

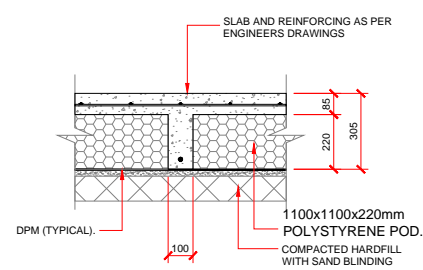

INTERNAL RIB DETAIL

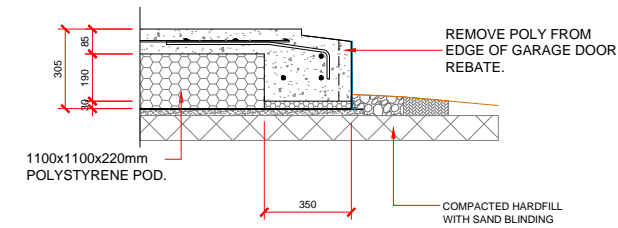

GARAGE DOOR REBATE DETAIL

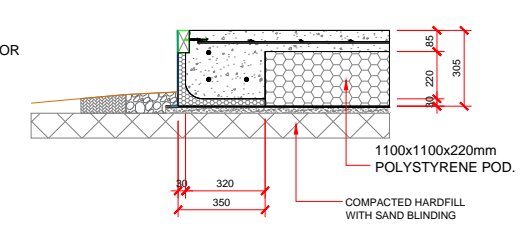

JOINERY REBATE DETAIL

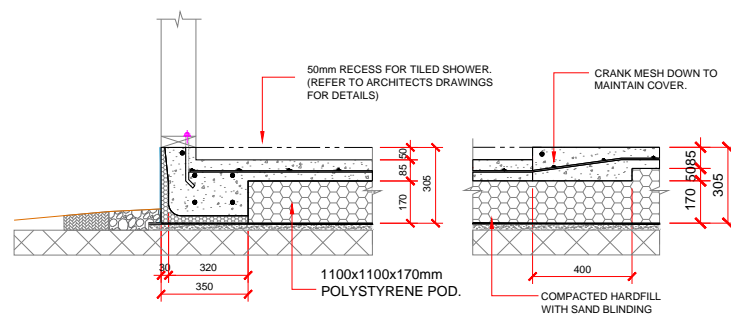

SHOWER RECESS DETAIL - 140mm FRAMING.

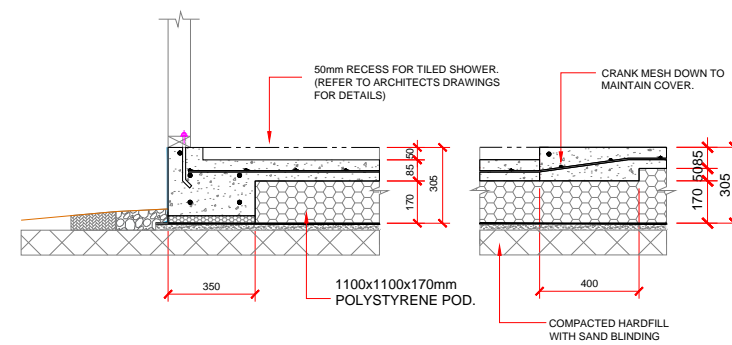

SHOWER RECESS DETAIL - 90mm FRAMING.

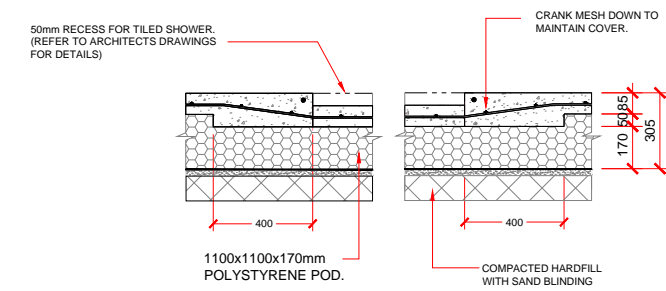

SHOWER RECESS DETAIL.

MAX85 DETAILS - 305mm

DWG NO.

DATE : 2023