



NOVEMBER 2017

# + Brick Veneer

## Technical Guide

NORTH ISLAND  
& SOUTH ISLAND





3	<b>Firth's Brick Range</b>
4	<b>10 Series - Architectural Masonry</b>
5	<b>Clear Sealing</b>
6	<b>Mortar</b>
7	<b>Joint Types</b>
8	<b>Laying Options &amp; Specifications</b>
10	<b>Wall Ties / Zoning Guide</b>
13	<b>The Brick Cavity</b>
15	<b>Weather Step</b>
16	<b>Cavity Ventilation</b>
17	<b>Openings / Lintels</b>
18	<b>Flashings</b>
20	<b>Brick Veneer Construction - Building Heights</b>
21	<b>Brick Veneer Tolerance</b>

The brick and supporting construction referred to in this section is to follow the requirements of New Zealand Building Code Section E2.AS1. The following standards are referenced in that section: NZS 3604 Timber Framed Buildings, NZS 4210 Masonry Construction: Materials and Workmanship. Additionally, the provisions of this section may be applied when used in conjunction with construction to NZS 4229, Concrete Masonry Buildings Not Requiring Specific Design. If the scope of the proposed work is outside the limitations and requirements of the above then specific engineering design advice must be sought.

## MANORSTONE®

Manorstone® is a larger masonry brick with a pleasant, almost soothing appearance resembling natural stone.



### STRAIGHT EDGE

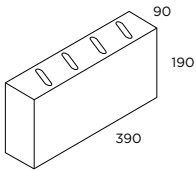

### RUMBLLED

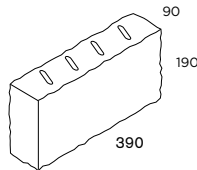

### BRICK SIZE



UNITS PER M<sup>2</sup>  
12.5

North Island - Manorstone® for every 4 units made, 3 are cored and 1 is solid.  
South Island - Manorstone® for every 5 units made, 4 are cored and 1 is solid.  
The solid units are for the window sill units, corners and jambs at openings.

### AVAILABLE COLOUR TONES:



Nth Island only

## DEVONSTONE®

Devonstone® is a medium sized brick combining warmth and natural charm, together with the durability and strength of concrete.



### STRAIGHT EDGED

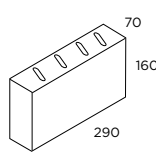

### RUMBLLED

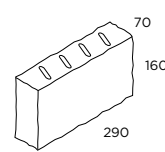

### BRICK SIZE



UNITS PER M<sup>2</sup>  
20

North Island - Devonstone® for every 7 units made, 5 are cored and 2 are solid.  
South Island - Devonstone® for every 7 units made, 6 are cored and 1 is solid.  
The solid units are for the window sill units, corners and jambs at openings.

### AVAILABLE COLOUR TONES:



Nth Island only

## FOCUS BRICK®

Focus Brick® is a smaller sized brick, with the clean, strong look of traditional bricks. A durable, low maintenance finish and smooth clean lines.



### STRAIGHT EDGE

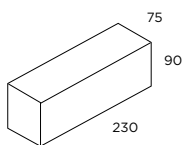

### BRICK SIZE



UNITS PER M<sup>2</sup>  
42 (70 SERIES)  
49 (90 SERIES)

Select best end for corners, sills and reveals.

### AVAILABLE COLOUR TONES:

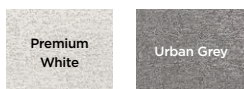

Nth Island only

## SUMMIT STONE®

Summit Stone® is available in three sizes, captures the timeless durability and striking beauty of natural stone.



### R1

BRICK SIZE **M**

SPLIT FACE

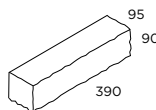

UNITS PER M<sup>2</sup>  
25

### R7

BRICK SIZE **M**

SPLIT FACE

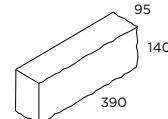

UNITS PER M<sup>2</sup>  
17

### R4

BRICK SIZE **L**

SPLIT FACE

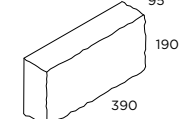

UNITS PER M<sup>2</sup>  
12.5

### AVAILABLE COLOUR TONES:



Nth Island only

Sth Island only

**Disclaimer:** Please keep in mind when choosing Firth concrete bricks, the beauty and appeal of concrete means there will be natural variation in colours. Colours may vary from batch to batch, and regionally as materials are natural and sourced locally. We advise viewing a current product sample before making your final decision, please contact your local Firth office and they will be happy to assist.

# 10 SERIES - ARCHITECTURAL MASONRY

SUITABLE FOR NON-STRUCTURAL FEATURES. HONED WALLS TRANSFORM INTO A GRANITE LOOK AND THERE IS A WIDE CHOICE OF ULTRA MODERN COLOURS AND FINISHES TO CHOOSE FROM. STACK BONDING DESIGN CREATES A MODERN DESIGNER LOOK OF CLEAN STRAIGHT LINES. AS WITH ALL FIRTH PRODUCTS, ARCHITECTURAL MASONRY IS ADVANCED MASONRY THAT INTEGRATES THE USE OF HIGH-PERFORMANCE MATERIALS WITH GOOD DESIGN DETAILING AND WORKMANSHIP.

## 10.01

BRICK SIZE

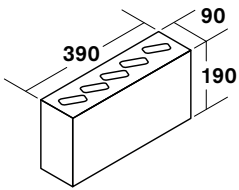

**Standard Whole**  
(also supplied as two core in some areas)

## H10.01

BRICK SIZE

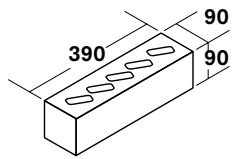

**Standard Whole, Half High**  
(also supplied as two core in some areas)

**MADE TO ORDER  
AVAILABLE COLOUR TONES:**

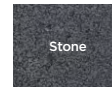

Note: Sill options can be a 517 or 1017.

Non-structural/brick construction as per NZS3604 or supported by NZS4229 and 4230.



**Disclaimer:** Colours may vary from region to region as all Firth Masonry products are made from natural materials which are locally sourced. Firth recommends viewing actual product, produced in your region, before making your final purchase decision. Special colours and mixes must comply with Firth's "Made to Order" policies which vary from region to region. Contact your local Firth office and they will be happy to assist.

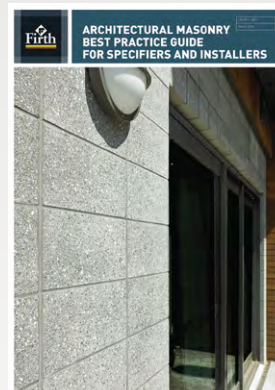

Refer to Firth's Architectural  
Masonry Installation Guide

[www.firth.co.nz](http://www.firth.co.nz)

# CLEAR SEALING

FIRTH RECOMMEND SEALING THE DARKER COLOUR BRICKS TO REDUCE EFFLORESCENCE AS SOON AS PRACTICAL RATHER THAN AFTER THE PROJECT IS COMPLETED. ALTHOUGH WEATHERTIGHTNESS IS NOT A COMPLIANCE REQUIREMENT, SUITABLE PRODUCTS SHOULD BE SELECTED TO PRE-CLEAN THE SURFACE, MINIMISE EFFLORESCENCE, PROVIDE A BARRIER TO ALGAL GROWTH OR GRAFFITI AND GIVE A 'WET-LOOK' TO THE BRICK SURFACE IF DESIRED. REFER TO THE SEALER MANUFACTURER'S INSTRUCTIONS FOR PRODUCT AND APPLICATION INFORMATION. THE FOLLOWING DRICON® SEALER PRODUCTS ARE RECOMMENDED.

## DRICON® MOISTURE REPELLENT (MR)



### AVAILABLE IN 5L /20L

A deep penetrating, general purpose moisture repellent for concrete and masonry surfaces. Moisture Repellent (MR) is suitable for: new & existing concrete, foundations, driveways, concrete pavers, masonry blocks, concrete brick veneers, polished concrete, concrete bench tops, coloured concrete, pre-cast/tilt-up

**FINISH:** CLEAR, NATURAL FINISH WITH MINIMAL CHANGE TO THE APPEARANCE OF THE SURFACE BEING TREATED.

## DRICON® SEMI GLOSS SEALER (SG)



### AVAILABLE IN 5L /20L

A low odour turpentine-based semi gloss sealer that will enhance the natural colour of concrete and masonry surfaces. Semi Gloss Sealer (SG) is suitable for: new & existing concrete, foundations, driveways, concrete pavers, masonry blocks, concrete bricks & veneer, polished concrete, concrete bench tops, coloured concrete, pre-cast/tilt-up

**FINISH:** GIVES A SEMI-GLOSS FINISH AND SURFACE COATING.

**NOTE:** Moisture Repellent (MR) Semi Gloss Sealer (SG) are not compliant with CCANZ CP01 Code of Practice for weathertight concrete and concrete masonry construction.

# DRICON® CONCRETE TREATMENT (CT)

EFFLORESCENCE REMOVAL & GENERAL CONCRETE CLEANER FOR CONCRETE PAVERS, BRICK, DECORATIVE CONCRETE.



- Water soluble for easy, residue free rinsing
- No acid fumes - can be used indoors and outdoors without special breathing equipment
- No corrosion or rusting of most metals in surrounding environment
- Non aggressive to skin & metals
- Significantly less corrosive to steel and aluminium compared to hydrochloric acid
- On-demand technology - Dricon® CT only becomes active when exposed to the target surface (concrete) unlike normal acids that release all their available activity immediately and indiscriminately

### AVAILABLE IN 1L /5L/ 20L

#### APPLICATIONS:

- LIGHT:** Removal of powdery dust and fines from new concrete / General etching ('acid washing') prior to sealing bricks and concrete
- MEDIUM:** Restoring decorative concrete, bricks & plaster work / Removing powdery efflorescence
- HEAVY:** Removing built up efflorescence / Cleaning concrete tools, pumps and mixers / Removing concrete, plaster and mortar build up

#### CONCENTRATION:

- LIGHT:** Use between 10 to 20 parts water to 1 part Dricon® CT. Wet the substrate prior to applying
- MEDIUM:** Use 4 parts water to 1 part Dricon® CT. Wet the substrate prior to applying
- HEAVY:** Use undiluted. Substrate, tools or build up should be dry prior to applying

\* When cleaning anodized aluminium framed windows, mask off the aluminium or rinse any run-off/overspray immediately.

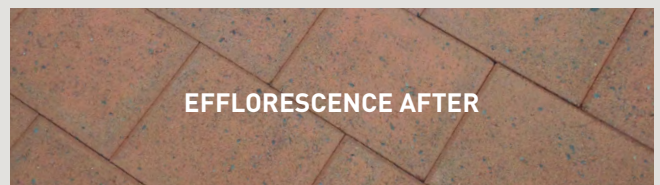
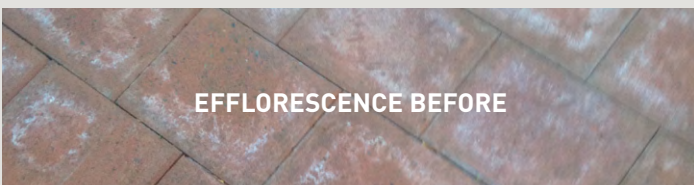

# MORTAR

**ON SITE MIX RATIO IS THREE BUCKETS OF SAND TO ONE BUCKET OF CEMENT. REMEMBER YOU MAY BE CALLED UPON TO VERIFY YOUR SITE MIX STRENGTH SO CYLINDERS SHOULD BE TAKEN AT REGULAR INTERVALS.**

The minimum requirement for Firth brick veneers is 12.5Mpa. The volume of water, additives, and mixing time, all need to be consistent to achieve a quality mortar of an even colour. If the temperature exceeds 27 degrees Celsius, ensure the bricks are kept damp for the first 24 hours to prevent rapid loss of moisture. Discard any mortar which is over 1.5 hours old, in summer; and for temperatures below 5 degrees Celsius discard after 2 hrs old. Avoid re-tempering mortar with water. NZS4210 sect 2.2.2.2 (e).

The correct time to tool a mortar joint is when a clear thumb print can be made on the surface. If joints are not tooled at the same moisture content they will vary in colour. Dricon bagged mortar is recommended for quality control to ensure compliance with the code. Refer to Firth's "+Concepts Designer brick + Architectural Masonry" brochure for available colours. Firth's Masonry Veneers Planner is an online tool to help you choose your size of brick and match it with your choice of coloured mortar.

Bricks	Notes	Size (W x H x D)	# Bricks Per m2	Bricks per 30kg Bag
<b>MASONRY</b>				
H10.01 block veneer	Cored	390 x 90 x 90	25	24 - 30
10.01 block veneer	Cored	390 x 190 x 90	12.5	18 - 24
<b>FIRTH</b>				
Devonstone®	70 series/Cored	290 x 160 x 70	19.6	40 - 46
Manorstone®	90 series/Cored	390 x 190 x 90	12.5	18 - 24
Focus® Brick & Pioneer	Solids	230 x 90 x 75	42.0	33 - 38
R1 Summit Stone®	Solids	390 x 90 x 95	25.0	35 - 40
R7 Summit Stone®	Solids	390 x 140 x 95	16.6	28 - 32
R4 Summit Stone®	Solids	390 x 190 x 95	12.5	18 - 24

## MORTAR JOINTS



### GROOVED JOINT

Also known as Concave or rolled. This type of joint is formed by using a curved steel jointing tool. Its recessed profile and tight seal mean that it is very effective at resisting moisture penetration. This type of joint can be good for hiding small irregularities. Should be tooled to a maximum depth of 6mm after initial stiffening has occurred.

## MORTAR JOINTS

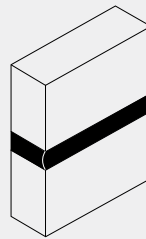

CONCAVE

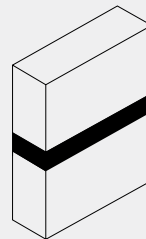

FLUSH

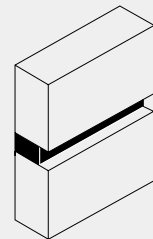

RAKED

Raked joints are not recommended for exterior.



### RAKED JOINT

For this type of joint the mortar is raked out and once pointed and tooled shall not exceed a maximum depth of 6mm. It is important to compact the mortar to improve its weather tight performance, this design creates a form of ledge where water can pool and therefore should only be used for internal walls.



### FLUSH JOINT

Firth does not recommend the use of flush joints unless they are compacted. If the mortar is flush jointed and not compacted it can lead to the following issues:

- When brick veneer is to be honed, the mortar can 'flick' out with honing process.
- When brick veneer is to be plastered it can lead to hairline cracking in the plaster where the outline of the brick can be seen.



## DRICON® ARCHITECTURAL MORTAR

Architectural Mortar is an ideal spreadable and workable mortar for use with the Firth's Architectural Masonry Bricks.

- Available in 3 colours
- Strength of 12.5MPa after 28 days
- Minimises on site waste
- Consistent colour & strength throughout the job
- Endorsed by BBFNZ
- Meets NZS 4210 Masonry Construction: Materials and Workmanship



## DRICON® COLOURED MORTARS

Coloured Mortar is an ideal spreadable and workable mortar for all types of masonry, brick and stone work.

- Available in 15 colours
- Strength of 12.5MPa after 28 days
- Minimises on site waste
- Consistent colour & strength throughout the job
- Endorsed by BBFNZ
- Meets NZS 4210 Masonry Construction: Materials and Workmanship

# JOINT TYPES

Figure 1 shows some of the tooling details commonly practiced. Some are not recommended for external application because of their poorer weatherproofing properties, but this will be of lesser significance where cavity protects the inner wall.

Because of the positive barrier to ingress of moisture, any of the joint details illustrated in Figure 1 may be applied to external cavity or brick veneer walls without risk to inside finishes.

Of the details shown, types A, B and C are suitable for internal or external use. Raked and extruded joints should not be used externally except in cavity or brick veneer construction. Raked joints will also accentuate the normal horizontal rough edge on brick veneer blocks and increase the potential for efflorescence to present.

The flush joint is recommended only for walls which receive a later applied finish or coating.

The joints A, B and C, should only be tooled to a maximum depth of 6mm after initial stiffening has occurred. The delaying of the tooling operation is vital if a tight weatherproof joint is to be produced in horizontal and, particularly, vertical joints.

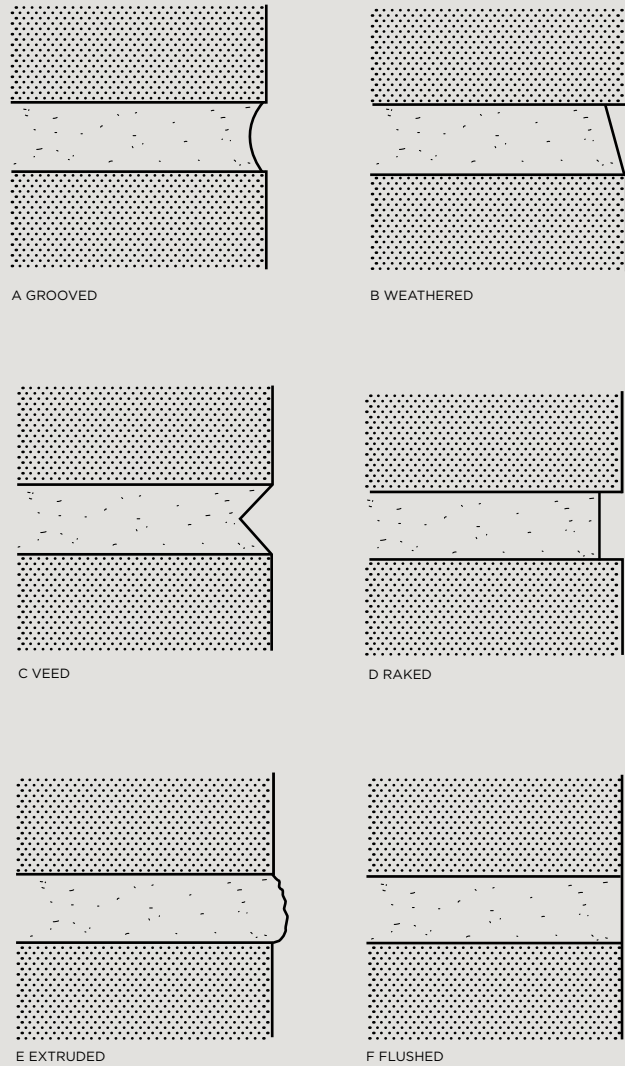

**FIGURE 1 : JOINT TYPES**

Reference: NZCMA Masonry Manual [www.nzcma.org.nz](http://www.nzcma.org.nz)

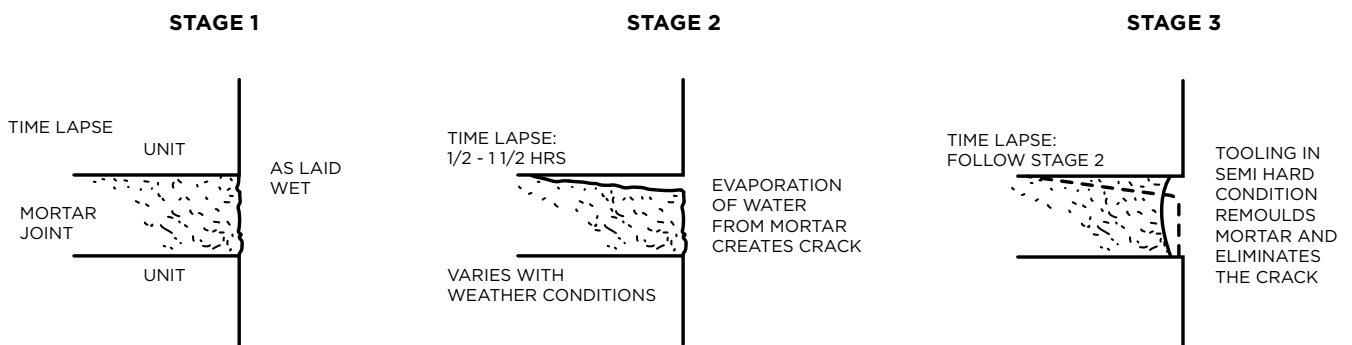

**FIGURE 2 : TOOLING OF JOINTS**

Reference: NZCMA Masonry Manual [www.nzcma.org.nz](http://www.nzcma.org.nz)

Figure 2 illustrates in an exaggerated way what is happening in the joint and how tooling gives an improved weather tightness. The whole matter of the tooling of external joints is of paramount importance and strict attention to delaying the operation after initial set of the mortar must be given.



## LAYING OPTIONS

STACK BOND IS OUTSIDE THE SCOPE OF NZS4229 & NZS 3604 AND THEREFORE REQUIRES SPECIFIC ENGINEERING DESIGN.

STACK BOND

To assist engineers a guide for 10series (90mm wide) is available from the New Zealand Concrete Masonry Association website under the Masonry Manual/Veneers/Veneer - Stack bond. [www.nzcma.org.nz](http://www.nzcma.org.nz)

Studs in timber framed walls to be at 400mm centres. Wall ties, to the requirements of NZS 4210, are to be provided at 400mm centres both vertically and horizontally.

Lattice mesh shall be laid continuously in horizontal courses at 800mm maximum vertical centres, commencing no higher than the second course above the brick veneer base.

Lattice mesh shall also be laid in the course or courses directly above and below openings, extending a minimum 800mm past the edge of the opening.

Lap joins in lattice mesh shall be made at midlength of 390mm block units and shall be staggered so that adjacent laps do not occur within the same vertical block stack. Lattice mesh may be discontinued only at control joints.

Use purpose made 'L' formed lattice mesh at corner intersections.



RUNNING OR STRETCHER BOND



# LAYING OPTIONS CONT.

## LATTICE MESH SHALL BE EAGLE WIRE BRICKLOCK, OR EQUIVALENT, AND COMPLY WITH THE FOLLOWING REQUIREMENTS:

Comprise 2 parallel longitudinal steel rods of minimum 4mm diameter, held apart approximately 55mm on centre by welded cross wires of 2mm diameter, at 200mm centres.

Steel shall have a minimum yield strength of 300 MPa and be hot dip galvanised to minimum 470gm/m<sup>2</sup>. Mesh to be supplied and installed in minimum 2m length modules, lapped to detail shown in figure below.

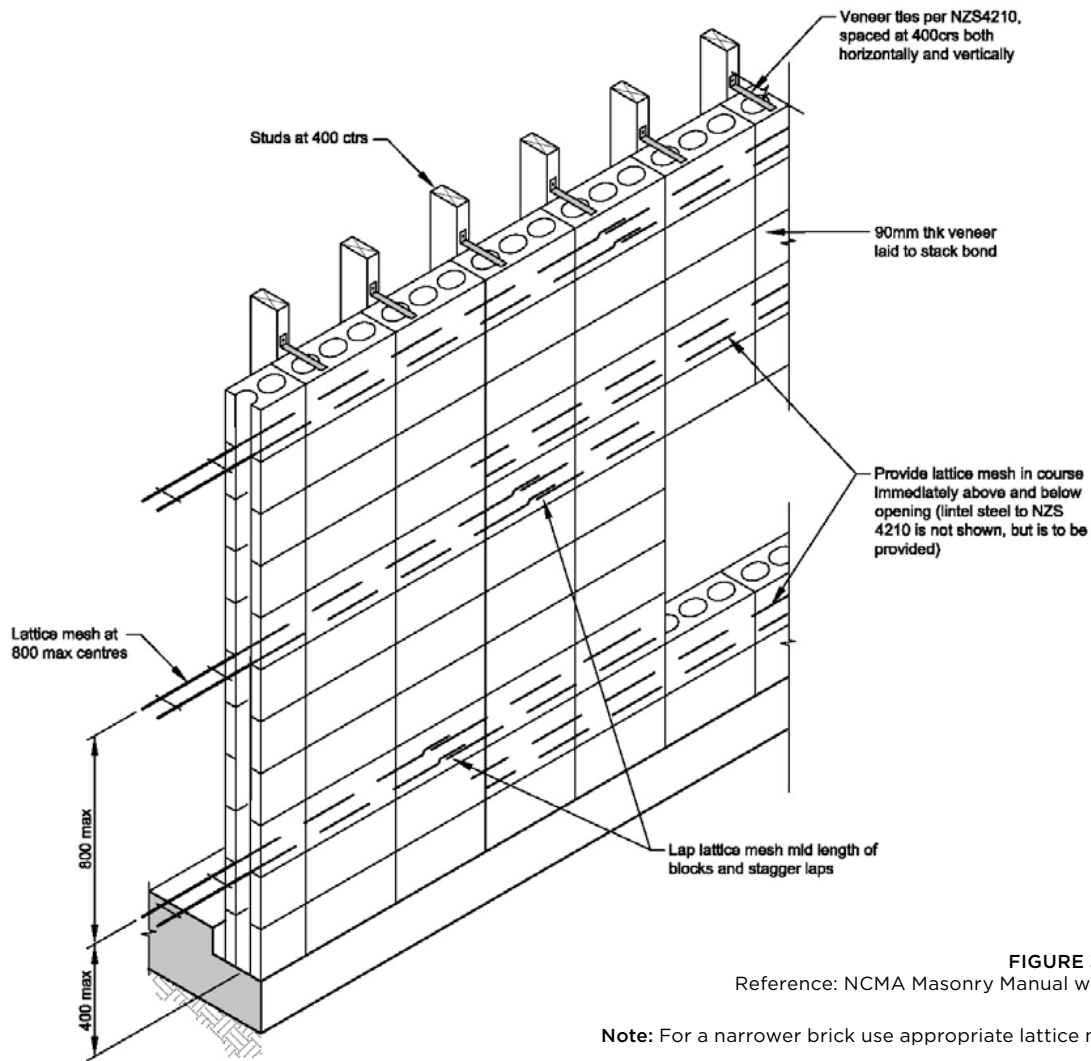
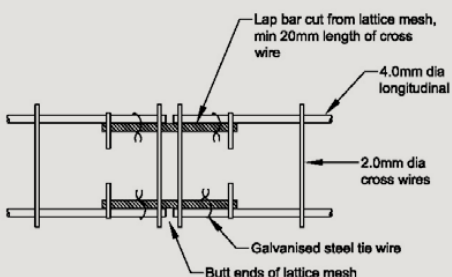

FIGURE 3: LATTICE MESH  
Reference: NCMA Masonry Manual [www.nzcma.org.nz](http://www.nzcma.org.nz)

Note: For a narrower brick use appropriate lattice mesh to get cover

## BEDDING DETAILS



LATTICE MESH LAP DETAIL

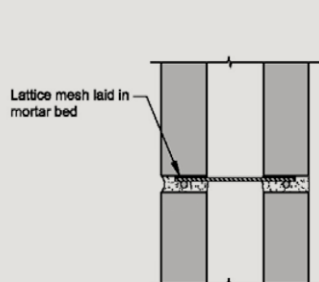

LATTICE MESH

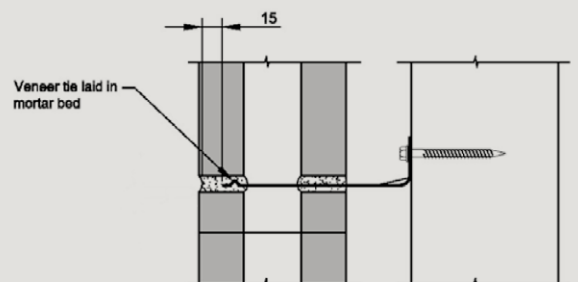

WALL TIE

# WALL TIES / ZONING GUIDE

Wall ties and screws shall be determined by the durability zone outlined in NZS 3604 and as outlined in E2/AS1 table 18A and 18C.

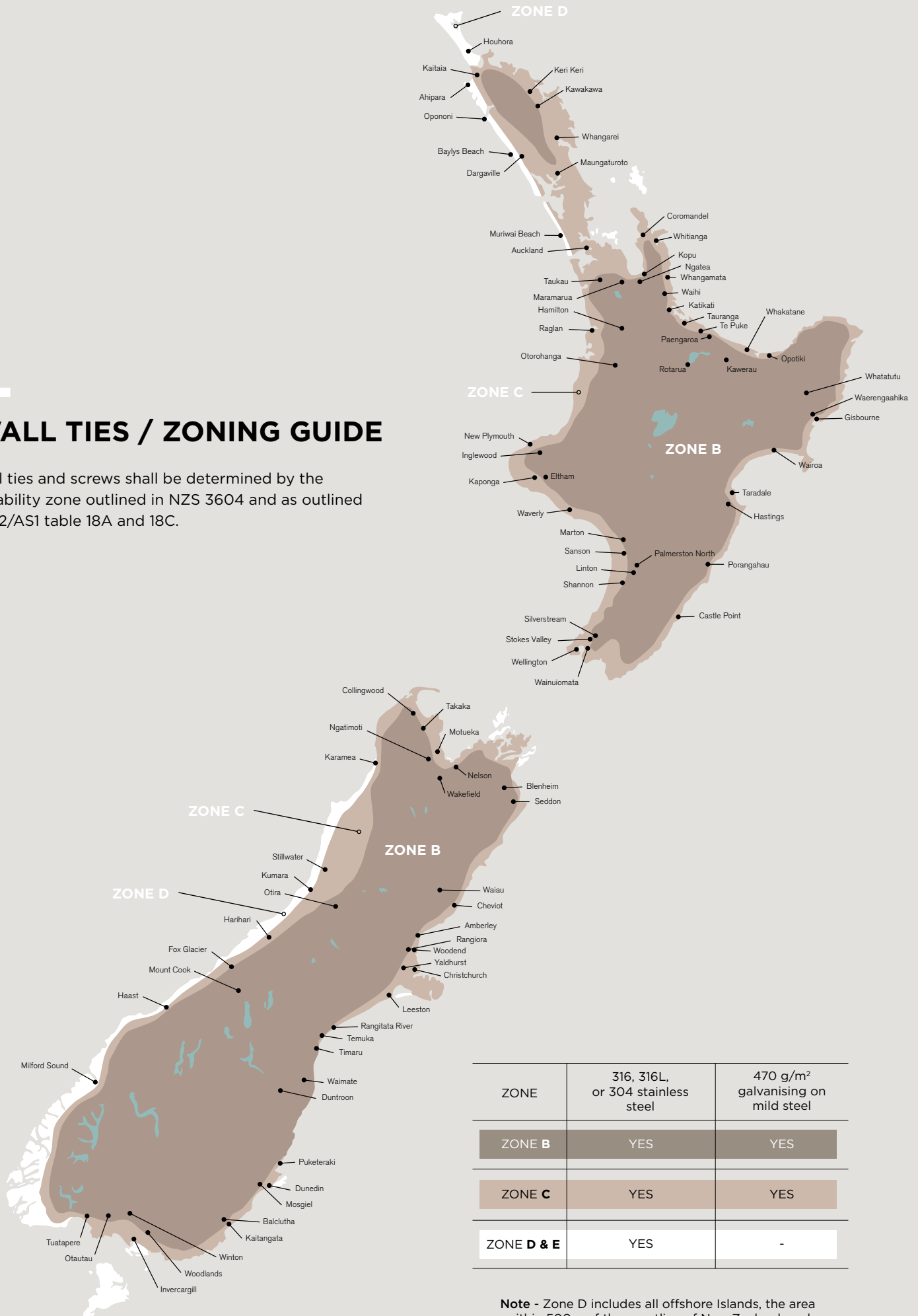

ZONE	316, 316L, or 304 stainless steel	470 g/m <sup>2</sup> galvanising on mild steel
ZONE B	YES	YES
ZONE C	YES	YES
ZONE D & E	YES	-

**Note** - Zone D includes all offshore Islands, the area within 500m of the coastline of New Zealand, and those areas shown in white. The map shall be read in conjunction with 4.2.2.

**TABLE 18A  
SPECIFICATION OF MAXIMUM TIE SPACINGS FOR TYPE B (4) BRICK VENEER TIES  
PARAGRAPH 9.2.7**

SEISMIC ZONE  REFER NZS 3604	MASONRY BRICK VENEER LESS THAN 180 KG/M <sup>2</sup>			MASONRY BRICK VENEER 180-220 KG/M <sup>2</sup>			MASONRY BRICK VENEER MORE THEN 220 KG/M <sup>2</sup>
	TIE TYPE (4)(5)	MAXIMUM SPACINGS (1)		TIE TYPE (4)(5)	MAXIMUM SPACINGS (1)		
		HORIZONTAL	VERTICAL		HORIZONTAL	VERTICAL	
1	EL	600	400	EM	600	400	SED (2)
2 (6)	EM	600	400	EH (3)	600	400	SED (2)
3	EH (3)	600	400	EH (3)	600	400	SED (2)
4	SED (2)	SED (2)	SED (2)				

**NOTES:**

1. Maximum masonry tie spacings of 600mm horizontally and 400mm vertically
2. Spacing of ties to be determined by specific engineering design
3. EM may be used if the horizontal spacings do not exceed 400mm and the vertical spacings to not exceed 300mm
4. Type B and Prefix E indicate masonry ties manufactured to AS/NZS 2699.1
5. L (Light), M (Medium), H (High) indicate strength capability of ties in AS/NZS 2699.1
6. Use seismic zone 2 (minimum) for Christchurch region comprising Christchurch City, Waimakariri District and Selwyn District

Reference: Acceptable Solution E2/AS1

**COMMENTS**

Variations in cavity width will require compensating adjustments to the length of masonry tie used. Refer to Brick Weights and Weather Step Dimensions table on page 15.

### 2.7.3 CLASSIFICATION OF TYPE B TIES

Brick veneer ties for use in seismic areas shall be classified in accordance with their characteristic strength and stiffness as show in Table 2. The classification is as follows:

- (a) Earthquake light duty (EL).
- (b) Earthquake medium duty (EM).
- (c) Earthquake heavy duty (EH).

**TABLE 2  
TYPE B BRICK VENEER TIES (FLEXIBLE OR NON-FLEXIBLE)**

MINIMUM CHARACTERISTIC STRENGTH AND CHARACTERISTIC STIFFNESS UNDER AXIAL LOADING

CLASSIFICATION FOR SEISMIC BRICK TIE	MINIMUM CHARACTERISTIC AXIAL STIFFNESS kN/MM	MINIMUM CHARACTERISTIC AXIAL STRENGTH (AT THE END OF 4TH, 10 MM TENSION CYCLE) kN	MINIMUM CHARACTERISTIC RESIDUAL STRENGTH (AT END OF 15 MM CYCLE) kN
Light duty (EL)	0.150	0.500	0.350
Medium duty (EM)	0.175	0.750	0.550
Heavy duty (EH)	0.200	1.500	1.100

**NOTE:** Type B non-flexible brick veneer ties are known as 'standard ties' in New Zealand.

Reference AS/NZS 2699.1

## WALL TIES - 9.2.7

Brick veneer shall be attached to wall framing by wall ties. Wall ties and their spacings and embedment shall be in accordance with the requirements of NZS 4210 and E2/AS1 Tables 18A, 18B and 18C. Screw fixings shall be minimum 12 gauge, 35mm long hex washer face, galvanised or stainless steel to suit the ties required under Table 18C.

**TABLE 18B PLACEMENT OF WALL TIES  
PARAGRAPH 9.2.5 AND 9.2.7**

LOCATION	PLACEMENT OF MASONRY TIES
Unsupported panel sides and edges of openings	Within 300mm of panel side or edge
Top of brick veneer panels and top of panels under openings	Within 300mm or two courses (whichever is the smaller) of top of brick
Bottom of brick veneer panel in masonry rebate sealed with liquid applied damp-proof course Bottom of brick veneer panel supported on steel angle lintel	Within 300mm or two courses (whichever is the smaller) from bottom of brick
Bottom of brick veneer panel in masonry rebate with membrane damp-proof course	In each of the first two courses

**NOTES:** Ties are to be screw fixed (ie. non-impact method) using screws outlined in Table 24.

Reference: Acceptable Solutions E2/AS1 External Moisture

The tie length is governed by the cavity width and the width of the brick veneer being laid. The tie when fixed should extend to a minimum of half way across the width of the brick but also have a minimum cover of 15mm to the outside. The tie should also have a 5 degree downslope from the frame. Ties should also be positioned within 300mm of openings.



# THE BRICK CAVITY

The minimum cavity width is 40mm and the maximum is 75mm - (E2/AS1 Fig 73D and section 9.2.6 Cavities). It's important to maintain the minimum cavity width of 40mm after allowing for construction tolerances and thickness of wall underlays and sheet bracing. E2/AS1 allows for a maximum overhang of 20mm. Mortar should not encroach into the cavity more than 5mm (NZS4210).

**FIGURE 73D  
MASONRY BRICK VENEER DETAILS**

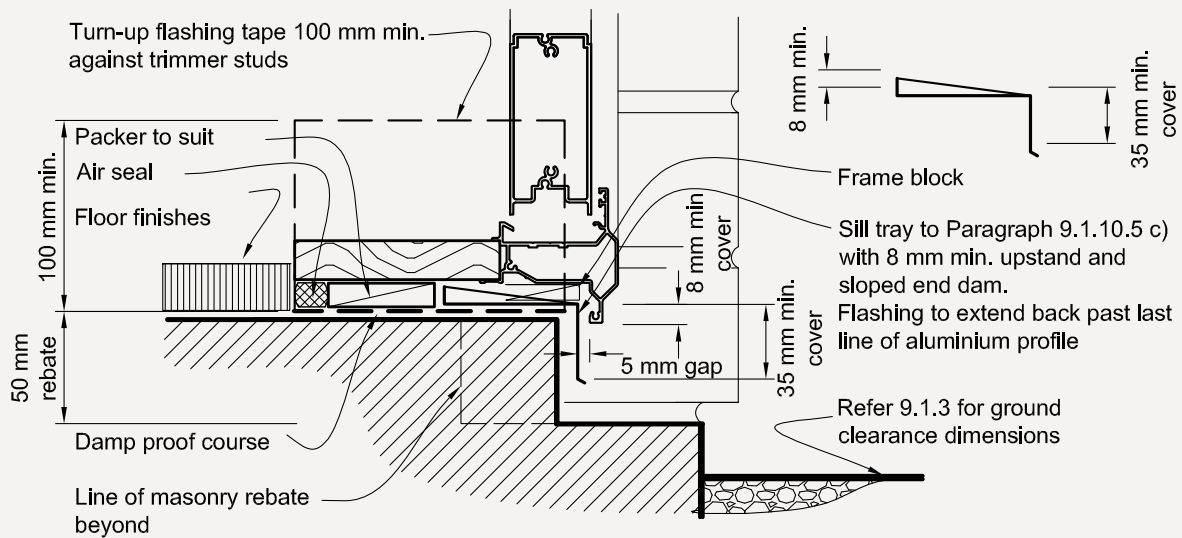

**(h) MASONRY BRICK VENEER - DOOR SILL**

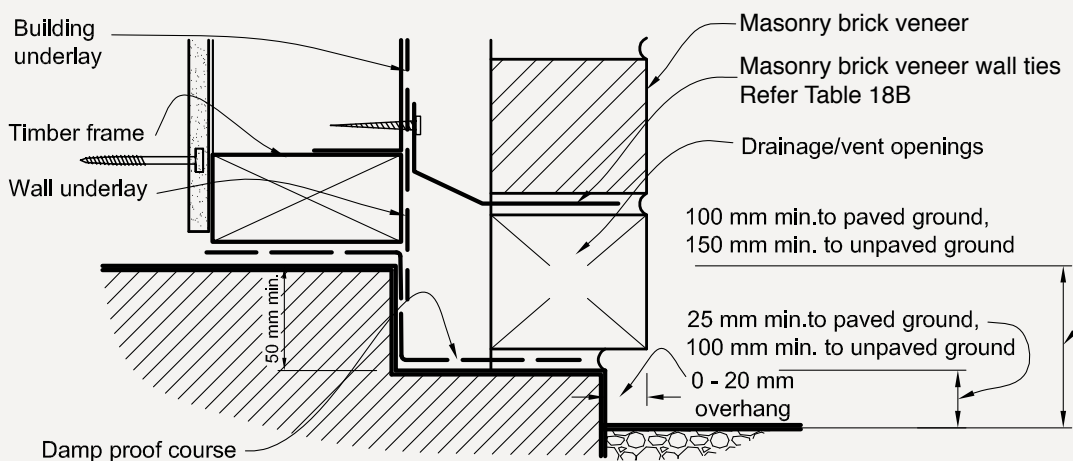

**(i) MASONRY BRICK VENEER - FLOOR REBATE DETAIL**

Reference: Acceptable Solutions E2/AS1 External Moisture

# THE BRICK CAVITY CONT.

FIGURE 73D CONT.

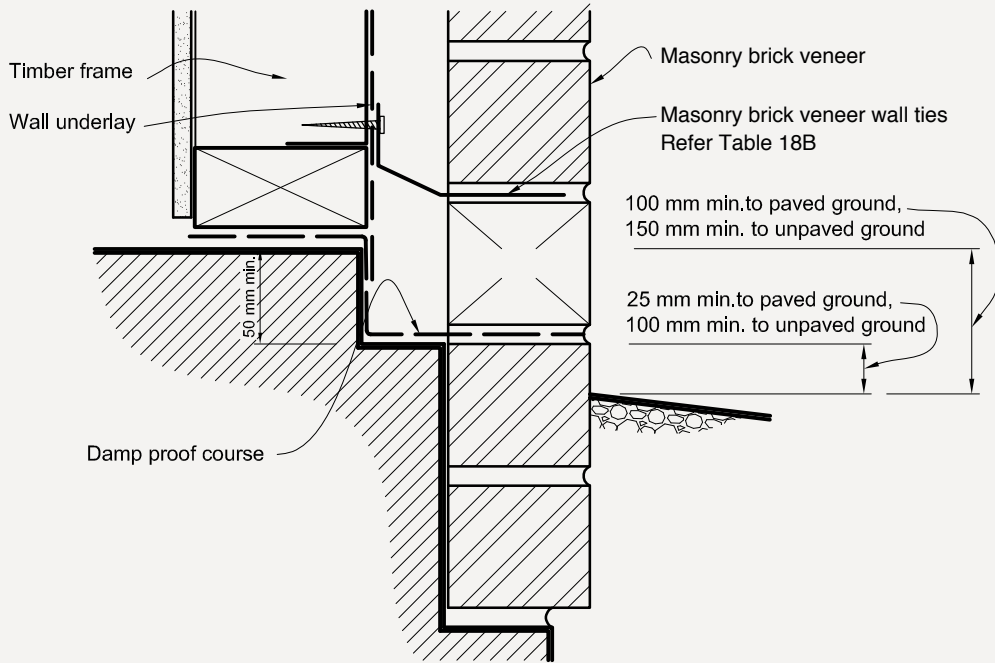
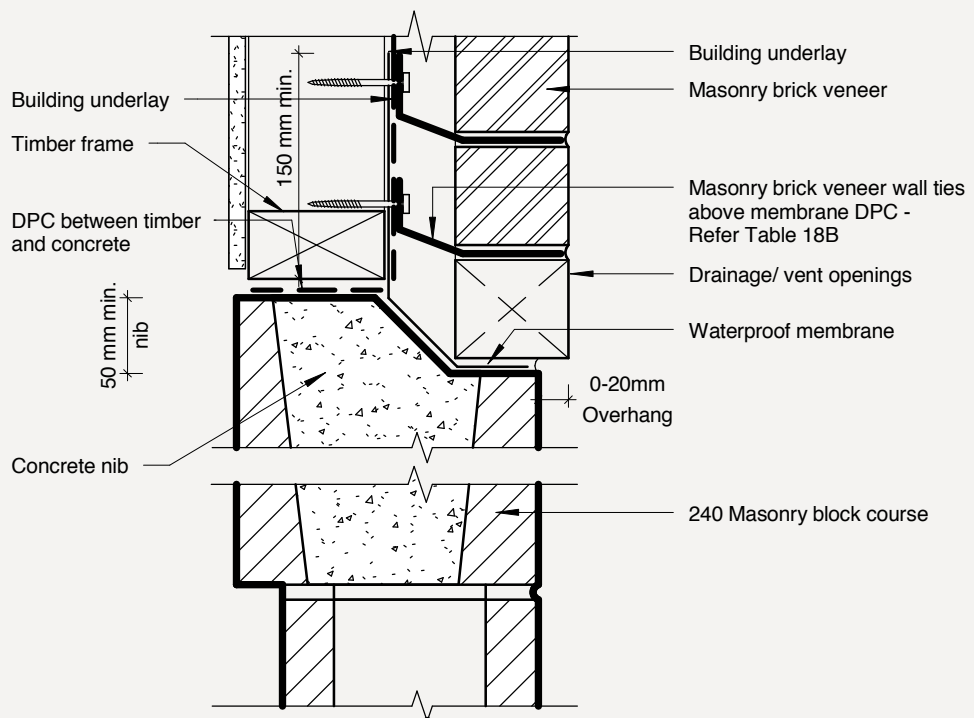

FIGURE 73E

(j) MASONRY BRICK VENEER - MASONRY BELOW GROUND



(k) MASONRY BRICK VENEER - ABOVE GROUND SUPPORT

# WEATHER STEP/SLAB RECESS

The minimum depth of the rebate is 50mm (E2/AS1 Fig 73D) however its common to see the depths specified at 100mm for added safety to prevent the ingress of moisture. A sloping concrete or mortar fillet at the base of the cavity to direct water to the outside prior to water proofing is good practice.

The code requires this rebate to have a damp proof course. (E2/AS1 section 9.2.5 Foundation Support and Damp Proofing.)

## DAMP PROOFING MATERIAL SHALL BE EITHER

### REBATES LOWER THAN GROUND FLOOR LEVEL:

- Two coats of bituminous liquid, or
- 1mm of butyl rubber or bituminous sheet, or
- 0.25mm polythene or polyethylene damp proof membrane.

### FOR REBATES ABOVE GROUND LEVEL:

- 1mm of butyl rubber or bituminous sheet, or
- 0.25mm polythene or polyethylene damp proof membrane.

Lap joints in flashings minimum of 150mm.



DAMP PROOF ON WEATHER STEP

Reference: Acceptable Solutions E2/AS1 External Moisture

## BRICK WEIGHTS AND WEATHER STEP DIMENSIONS

NAME	SIZE (mm)	UNITS (M <sup>2</sup> )	NORTH ISLAND		SOUTH ISLAND		WEIGHTS PER M <sup>2</sup> TABLE 18A CLASSIFICATION	CAVITY WIDTH (40-75mm)	SLAB RECESS WIDTH (NO OVERHANG)	SLAB RECESS DEPTH MINIMUM
			UNIT WEIGHT (KG)	WEIGHT (KG/m <sup>2</sup> )	UNIT WEIGHT (KG)	WEIGHT (KG/m <sup>2</sup> )				
MANORSTONE <sup>®</sup> (WITH CORES)	390 LONG x 190 HIGH x 90 WIDE	12.5	11	148	12.2	165	LESS THEN 180KG/M <sup>2</sup>	40MM	130-140MM	50MM
DEVONSTONE <sup>®</sup> (WITH CORES)	290 LONG x 160 HIGH x 70 WIDE	20	5.8	125	6.2	133	LESS THEN 180KG/M <sup>2</sup>	40MM	110-120MM	50MM
FOCUS <sup>®</sup> BRICK (NO CORES, NO FROG)	230 LONG x 90 HIGH x 75 WIDE	42	3.3	158	3.4	163	LESS THEN 180KG/M <sup>2</sup>	40MM	115-125MM	50MM
FOCUS <sup>®</sup> BRICK (NO CORES, NO FROG)	230 LONG x 75 HIGH x 90 WIDE	49	3.3	188	3.4	193	180-220KG/M <sup>2</sup>	40MM	130-140MM	50MM
ARCH MASONRY 1001 (WITH CORES)	390 LONG x 190 HIGH x 90 WIDE	12.5	11	148	12.2	165	LESS THEN 180KG/M <sup>2</sup>	40MM	130-140MM	50MM
SUMMIT STONE <sup>®</sup> R1 (NO CORES, NO FROGS)	390 LONG x 90 HIGH x 95 WIDE	25	7	200	7.6	217	180-220KG/M <sup>2</sup>	40MM	135-145MM	50MM
SUMMIT STONE <sup>®</sup> R7 (NO CORES, NO FROGS)	390 LONG x 140 HIGH x 95 WIDE	17	11	200	11.8	217	180-220KG/M <sup>2</sup>	40MM	135-145MM	50MM
SUMMIT STONE <sup>®</sup> R4 (NO CORES, NO FROGS)	390 LONG x 190 HIGH x 95 WIDE	12.5	14.2	192	15	203	180-220KG/M <sup>2</sup>	40MM	135-145MM	50MM

\* Weights Kg per m2 including mortar

# CAVITY VENTILATION

Drainage/weep/vent holes should be a minimum of 75mm high and the width of the mortar joint. They should be installed at centres not exceeding 800mm. If the vent holes are less than 75mm high decrease the spacing to achieve a ventilation area of 1000mm<sup>2</sup>/m wall length. The cavity shall be ventilated to the outside at the top of walls by either similar vents as at the bottom, or a continuous 5mm minimum gap between the top course and soffit board, with a cover bead to outside that maintains a minimum 2mm gap to masonry (E2/AS1 section 9.2.6 (d) Cavities and Fig 73E). It is good practice to install vent holes under window sills over 2.4m wide. The cavity shall be sealed off from the floor and roof space.

**FIGURE 73 E  
MASONRY BRICK VENEER  
SOFFIT DETAIL**

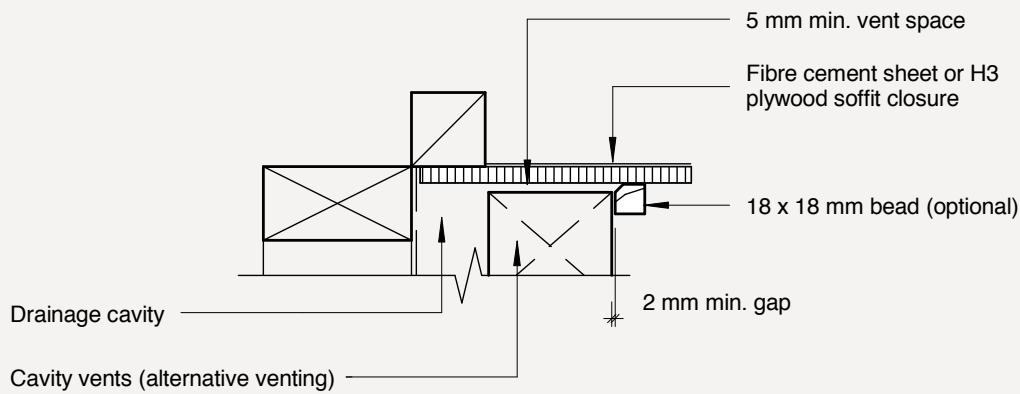

**MASONRY BRICK VENEER  
CANTILEVER UPPER FLOOR**

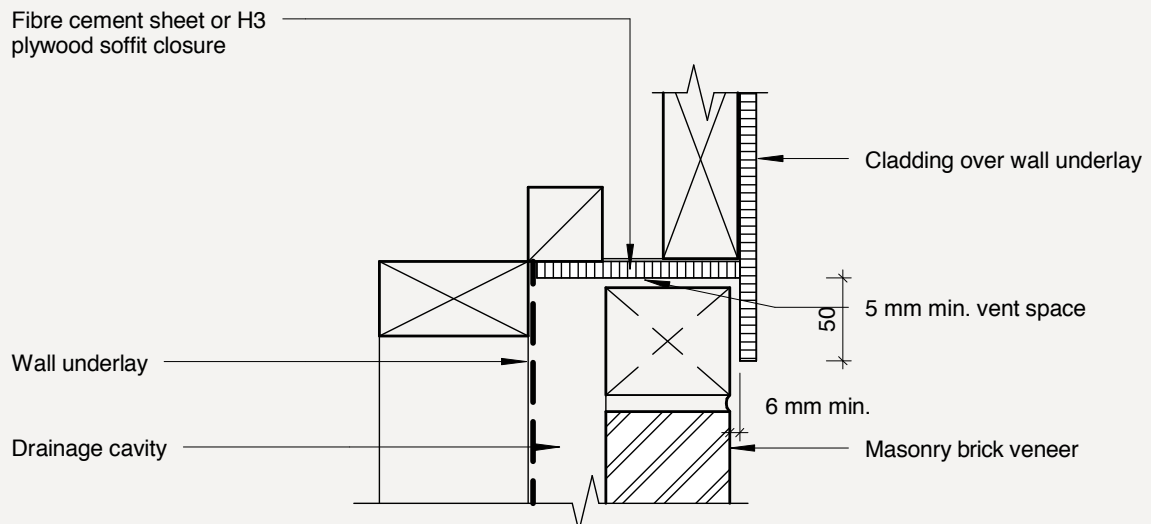



# OPENINGS / LINTELS

## LINTELS CAN BE INSTALLED 2 DIFFERENT WAYS:

### 1 ANGLE IS SUPPORTED BY THE BRICK

Seating as per E2/AS1 section 9.2.9 Openings in brick veneer

- Minimum seating into adjacent brick of:
- A) 100mm for spans up to and including 2m
  - B) 200mm for spans over 2m

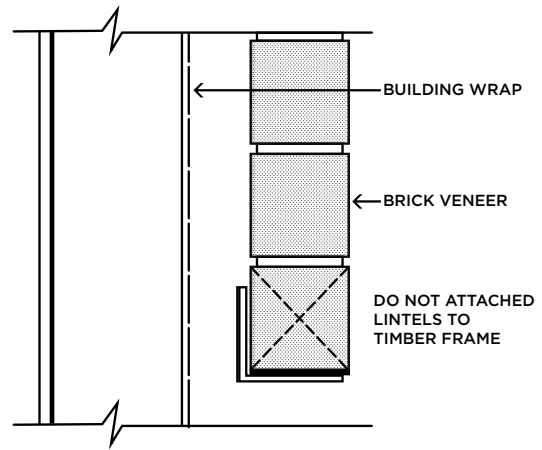

### 2 ANGLE IS FIXED TO THE TIMBER FRAME

Keep the angle 5mm short of the openings at each end to allow for movement

Lintel coach-screwed to timber framing using 75mm x 10mm screws at 400 centres

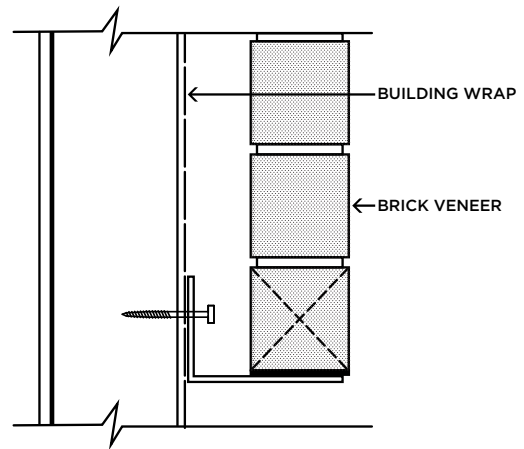

TABLE 18E - MASONRY BRICK VENEER LINTEL SIZES (MINIMUM)

All lintels shall comply with the corrosion requirements as in Table 18D and exposure zones as in NZS3604.

**SEE PAGE 10 FOR MAPS AND ZONING GUIDE**

SPAN OF LINTEL (M) UP TO:	MAXIMUM THICKNESS OF MASONRY BRICK VENEER (MM)					
	70			90		
	MAXIMUM HEIGHT OF BRICK VENEER SUPPORTED (MM)					
	350	700	2000	350	700	2000
0.800	60 x 60 x 6L	60 x 60 x 6L	60 x 60 x 6L	60 x 80 x 6L	60 x 80 x 6L	80 x 80 x 6L
2.000	60 x 60 x 6L	60 x 60 x 6L	60 x 60 x 6L	60 x 80 x 6L	60 x 80 x 6L	80 x 80 x 6L
2.500	60 x 60 x 6L	80 x 80 x 6L	80 x 80 x 6L	80 x 80 x 6L	80 x 80 x 6L	80 x 80 x 6L
3.000	80 x 80 x 6L	80 x 80 x 6L	125 x 75 x 6L	80 x 80 x 6L	80 x 80 x 8L	90 x 90 x 10L
3.500	80 x 80 x 6L	80 x 80 x 6L	125 x 75 x 6L	80 x 80 x 8L	90 x 90 x 10L	125 x 75 x 10L
4.000	80 x 80 x 8L	125 x 75 x 6L	125 x 75 x 10L	80 x 80 x 10L	125 x 75 x 6L	150 x 90 x 10L
4.500	125 x 75 x 6L	125 x 75 x 10L	-	125 x 75 x 6L	125 x 75 x 10L	-
4.800	125 x 75 x 6L	125 x 75 x 10L	-	125 x 75 x 6L	125 x 75 x 10L	-

# FLASHINGS

THE MOST IMPORTANT FLASHINGS ARE AROUND OPENINGS SUCH AS DOORS AND WINDOWS; THE HEAD FLASHING BEING THE CRITICAL ELEMENT. REFER E2/AS1 FIG 73C.

If a metal head flashing is used and fixed to the framing, ensure it is kept 5mm short at each end, and the ends of the flashing turned up. This will allow for any movement in the framing without interfering with the bricks. A 5 - 10mm gap between the underside of the lintel bar and the flashing allows for both drainage and ventilation eliminating the need for weep holes in the bricks across the head of the opening.

Jamb flashings are simple and inexpensive. Use a 200mm wide polyethylene flashing, tucked into the joinery flange.

The open end of the flashing is to be held off the building wrap using a kick-out batten or protruding clouts. The junction between the bricks and the joinery does not need to be sealed. The sill flashing is equally important; any moisture driven up the sill brick needs to be stopped from reaching the timber framing and directed into the bottom of the cavity as shown. Extend flashings 200mm past the sides of any openings where practical to do so. (NZS 3604 sect 11.7.7)

**FIGURE 73C - BRICK VENEER WINDOW AND DOOR INSTALLATION**

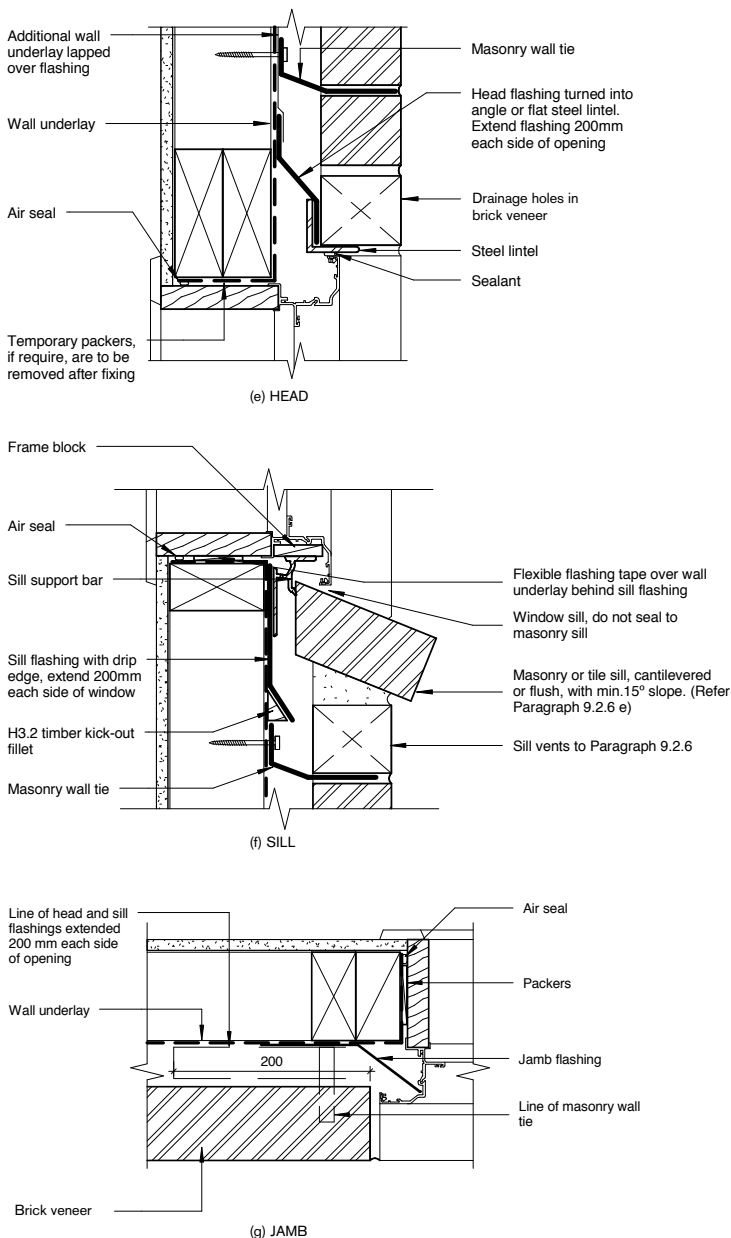

**ROOF TO WALL JUNCTION**

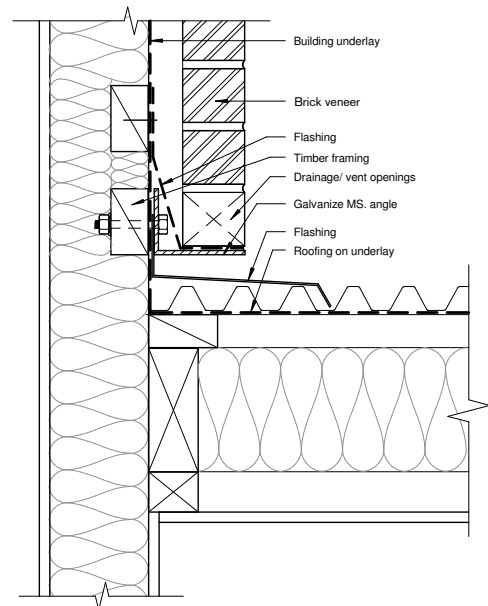

**TABLE 2.2 MAXIMUM TOLERANCES**

Item	Tolerances
Deviation from the position shown on plan for a building more than one storey in height	15mm
Deviation from vertical within a storey	10mm per 3m of height
Deviation from vertical in total height of building	20mm
Relative vertical displacement between masonry courses	
a) Nominated fair face (one side only)	3mm
b) Structural face	5mm
Relative displacement between loadbearing walls in adjacent storeys intended to be in vertical alignment	5mm
Deviation from line in plan	
a) In any length up to 10m	5mm
b) In any length over 10m	10mm total
Deviation of bed joint from horizontal	
a) In any length up to 10m	5mm
b) In any length over 10m	10mm total
Average thickness of bed joint, cross joint, or perpend	3 3mm on thickness specified

Note: Tolerances shall not breach minimum cavity widths.

# FIRTH CONTROL JOINT

## FIRTH CONTROL JOINT SPECIFICATION

### Construction

Control joints controlling wall movement shall be achieved by providing a bond break between blocks and mortar at the specified locations.

### Installation

At each control joint a thin layer of suitable polythene tape or similar shall be placed on top and at ends of each unit covering at least 75% of its width. The polythene layer must cover any cavities within the units. Mortar shall then be placed on the horizontal bed and the end of the unit to be laid.

### Location

Control joints shall be located at edges of windows closest to 4.0m intervals on each wall. Windows exceeding 3.0m in width shall have a control joint at each end. High windows of less than 800mm deep can be excluded. Spacing on plain walls shall not exceed 5.0m.

### Application

This alternative control joint is suitable for all Firth brick veneers except for plaster applications. H10.01 to comply with Firth 'Brick Construction Detail' document.

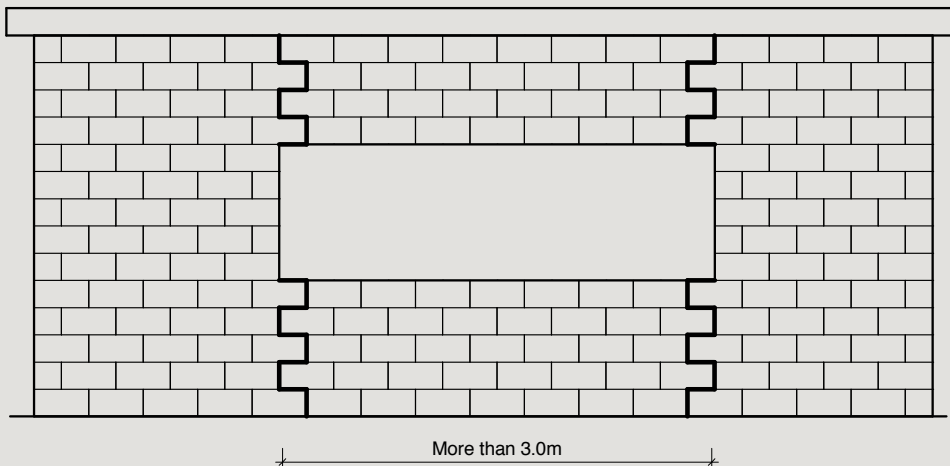
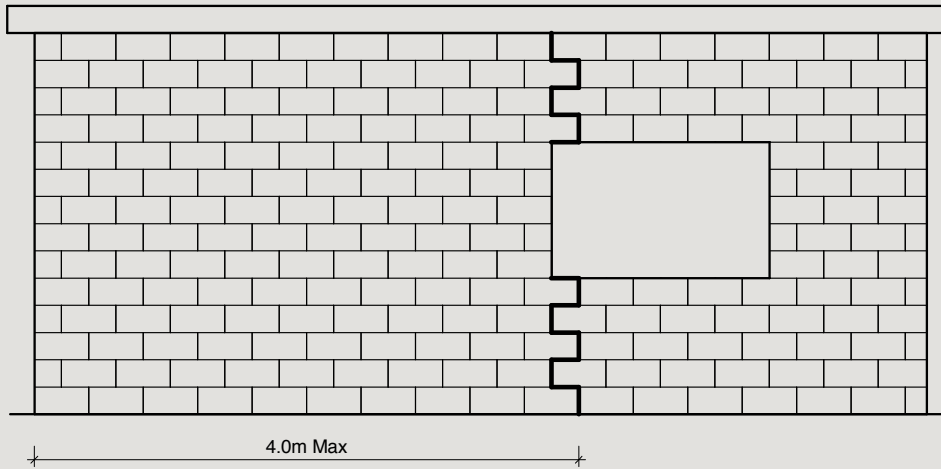

STITCH JOINT ELEVATION

# BRICK VENEER CONSTRUCTION - BUILDING HEIGHTS

THE MAXIMUM HEIGHT FOR SINGLE STOREY BRICKS IS 4.0M FROM THE FOUNDATION. AT THE GABLE AREA YOU MAY GO TO A MAXIMUM OF 5.5M TO THE APEX.

These requirements apply when the brick is supported by a timber frame, as stipulated in NZS3604. For masonry bricks refer to manufacturer's website for two storey design options. If the brick is supported by a masonry structure, NZS4229 permits a brick height of 6.0m for wall and up to 10.0m to the top of any gable. Also refer to E2/AS1 73B for other options.

## TWO STOREY BRICK VENEER

Refer to Firth's "Two Storey Masonry Veneer Design Solution" and "Devonstone Two Storey Construction Guide"

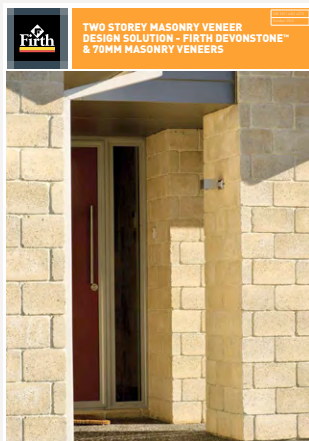
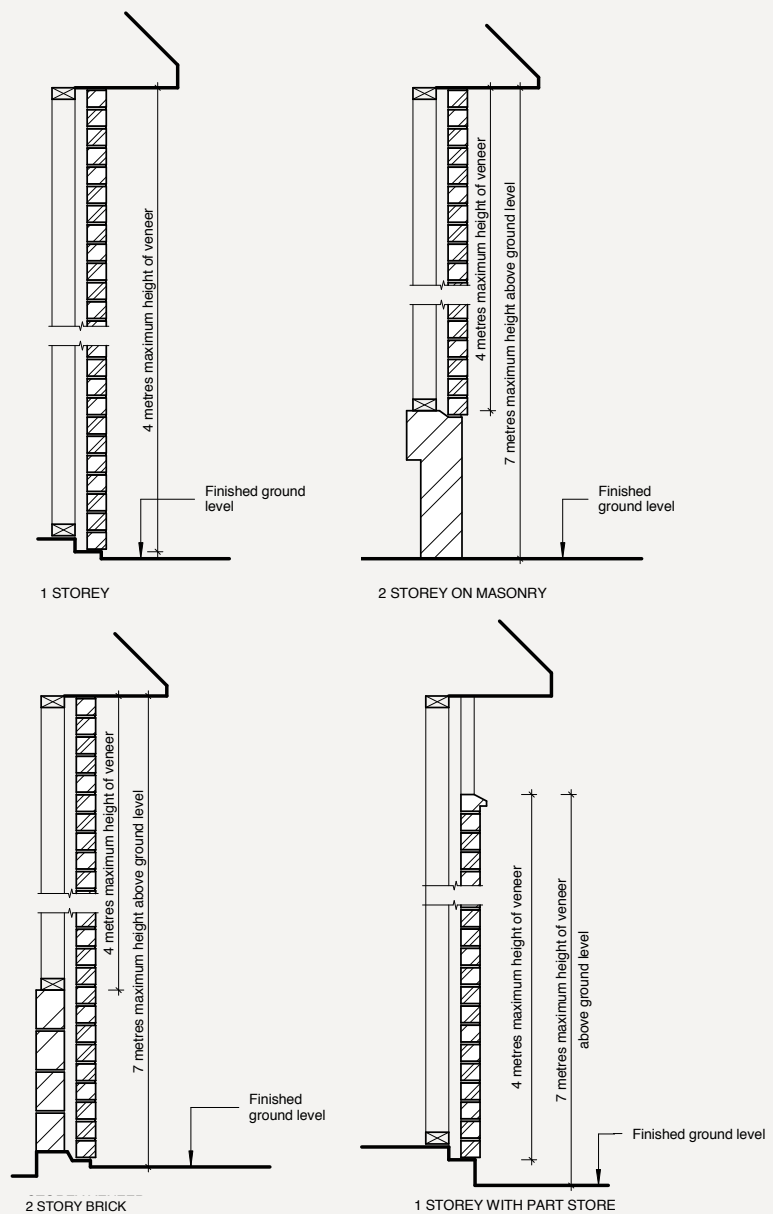

FIGURE 73B - MASONRY VENEER HEIGHT LIMITATIONS



# BRICK VENEER TOLERANCES & AESTHETIC APPEARANCE

IT IS POSSIBLE FOR A BRICK VENEER TO BE BUILDING CODE COMPLIANT BUT NOT HAVE THE VISUAL LOOK THAT REFLECTS THE SKILLS OF AN EXPERIENCED BRICKLAYER. THIS IS REFERRED TO AS 'WORKMANSHIP QUALITY'.

It is important to discuss with your bricklayer the aesthetic look you are hoping to achieve with your brick veneer and if possible, include them in your selection process.

The Brick and Blocklayers Federation recommends that parties to a brick construction enter into a clear, written contract that sets out the expectations of parties including agreed workmanship quality standards, quality checking responsibilities and an agreement on how disputes will be managed – even if it is not a compulsory requirement under legislation.

## VIEWING DISTANCE

Due to the nature of bricks, no two bricks are the same and no brick is perfect when examined close-up. ASTM C90 has been adopted as the industry standard for viewing brickwork – it states that 'for exposed wall construction chips and imperfections shall not be evident when viewed from a distance of not less than 6.1m in diffused light'.

## CHIPPING

Bricks may be transported several times before arriving onsite and occasionally chipping can occur. Chips are more noticeable on bricks that have a surface colour different from the body of the brick. A workmanship quality standard is achieved if imperfections, including chips, are not visible when viewed from a distance of not less than 6.1m under diffused light as per ASTM C90.

New Zealand does not have a standard to assist a Bricklayer to evaluate the level of chipping acceptable in a brick prior to laying however ASTM C216-15 has been adopted by BBFNZ.

ASTM C216-15 for a general purpose face brick (FBS textured) basically has the following requirements:

- Chips from the edge should not be deeper than 8mm
- Corner chips should not be deeper than 13mm
- When all the length of the chips are added up that the total does not exceed 10% of the perimeter of the brick face (as an example, the accumulative lengths of the chips for a 230mm x 75mm brick shall not exceed 61mm).

Although brick veneers have two faces, it is good practice for Bricklayers to set aside bricks that do not meet this standard and to assess whether to discard it or use it for cuts.

**Reference: Brick and Blocklayers Federation New Zealand, "Brick Veneer Best Practice Guide" [www.bbfz.co.nz](http://www.bbfz.co.nz)**

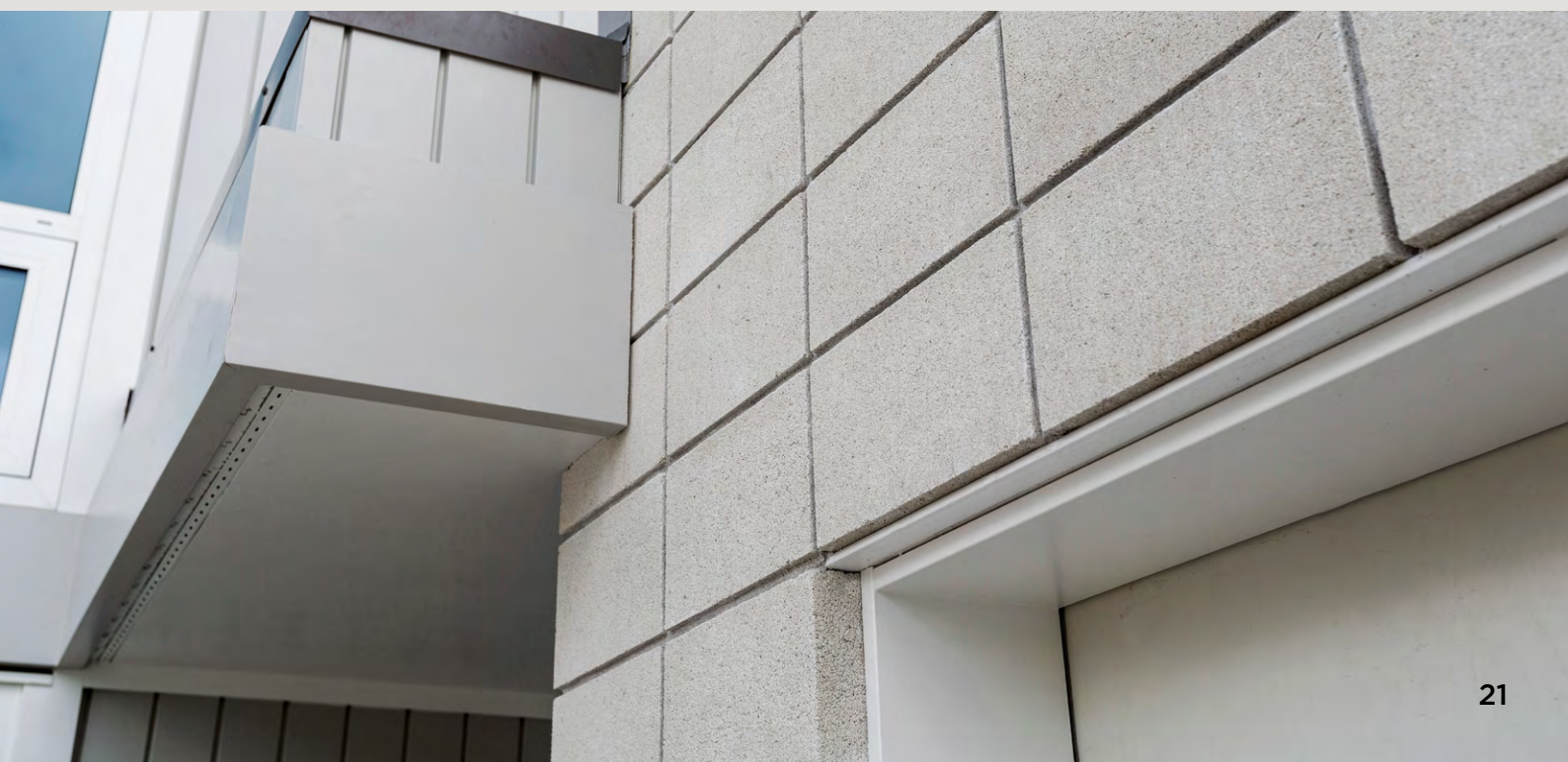



(C) Firth Industries 2017. All rights reserved. Content in this document is protected under the Copyright Act 1994. No material may be reproduced in whole or in part without the written consent of the copyright holder.



**0800 FIRTH 1** (347841)  
**FIRTH.CO.NZ**

 **PRODUCTSPEC**  
productspec.net

 **masterspec**  
masterspec.net